



ESSENTIAL FLOOD LIGHT



100-240Volts
50/60Hz

IP65

IK06

The LED Flood Light series offers a versatile and compact range of floodlights, designed with different output levels and boasting an impressive efficiency of up to 105 L/W. These flood lights are suitable for a wide array of applications, including wall-mounted installations around building facades. They are ideal for both classic flood lighting of buildings and illuminating outdoor areas.

In comparison to traditional flood lights, Honeywell LED Flood Lights provide immediate light without any startup or cooling-down times. With their robust aluminum housing and safety glass cover, these flood lights are specifically crafted for outdoor use, ensuring durability and reliability in various weather conditions.

APPLICATION AREAS



Public Areas



Industrial Areas



Car Park and Garage

FEATURES

- Illuminate with stunning efficiency, thanks to our products luminous efficacy of up to **105 lm/W**
- Experience enduring performance with an impressive lifetime of **30,000 hours (L70/B50)** with **3 years of warranty**
- Effortlessly customize your ambiance with two color temperature options: **3000K and 6500K**
- Enjoy reliable performance in demanding environments with robust IP65-rated protection against dust and water, along with IK06 impact resistance
- Operate seamlessly in temperatures ranging from **-20°C to +40°C** with our meticulously designed lighting
- Experience hassle-free compatibility with our lighting, supporting a wide nominal voltage range of **100-240V** and an operating frequency of **50/60Hz**
- Expanded Illumination: With a beam angle of **110 degrees**, our product can cover a larger area, eliminating dark spots and ensuring a well-lit environment
- Equipped with a robust **1 KV surge protection**, ensuring optimal safety for the electronic circuits inside during voltage spikes

TECHNICAL SPECIFICATIONS

ITEM CODE	ITEM DESCRIPTION	RATED POWER	RATED LUMENS	RATED CCT	RATED EFFICACY	BEAM ANGLE	CRI	DF
841930040102	Ess FL 30W 3000K 3150 100-240 V IP65 ND	30 W	3,150 LM	3000 K	105 LM/W	110 °	>80	>0.9
841965040122	Ess FL 30W 6500K 3150 100-240 V IP65 ND	30 W	3,150 LM	6500 K				
841930040132	Ess FL 50W 3000K 5250 100-240 V IP65 ND	50 W	5,250 LM	3000 K				
841965040152	Ess FL 50W 6500K 5250 100-240 V IP65 ND	50 W	5,250 LM	6500 K				
841930040162	Ess FL 70W 3000K 7350 100-240 V IP65 ND	70 W	7,350 LM	3000 K				
841965040182	Ess FL 70W 6500K 7350 100-240 V IP65 ND	70 W	7,350 LM	6500 K				
841930040012	Ess FL 100W 3000K 10500 100-240 V IP65 ND	100 W	10,500 LM	3000 K				
841965040032	Ess FL 100W 6500K 10500 100-240 V IP65 ND	100 W	10,500 LM	6500 K				
841930040042	Ess FL 150W 3000K 15750 100-240 V IP65 ND	150 W	15,750 LM	3000 K				
841965040062	Ess FL 150W 6500K 15750 100-240 V IP65 ND	150 W	15,750 LM	6500 K				
841930040072	Ess FL 200W 3000K 21000 100-240 V IP65 ND	200 W	21,000 LM	3000 K				
841965040092	Ess FL 200W 6500K 21000 100-240 V IP65 ND	200 W	21,000 LM	6500 K				

PRODUCT SIZE

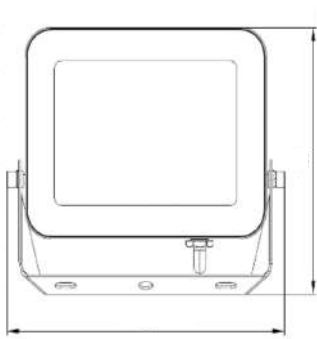

30W	50W	70W	100W	150W	200W
164*139*29MM	183*169*29MM	216*189*33MM	254*217*33MM	327*265*33MM	405*326*36MM

POLAR INTENSITY DIAGRAM

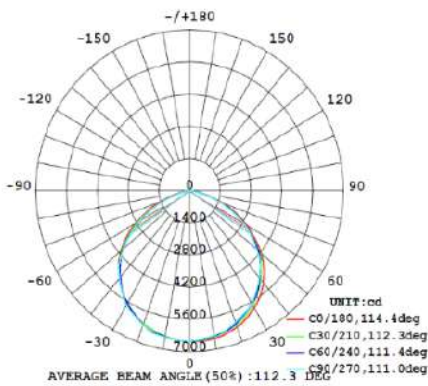

30 W

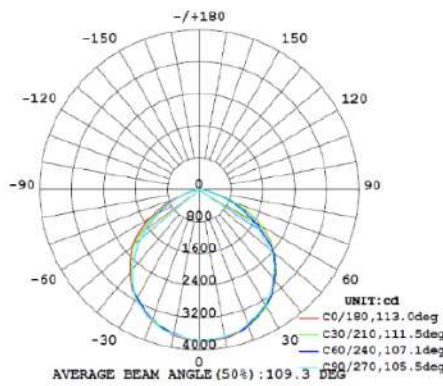

50 W

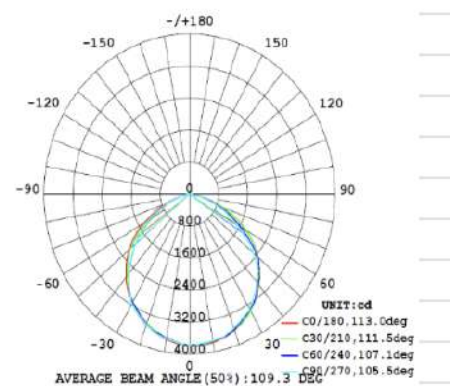

70 W

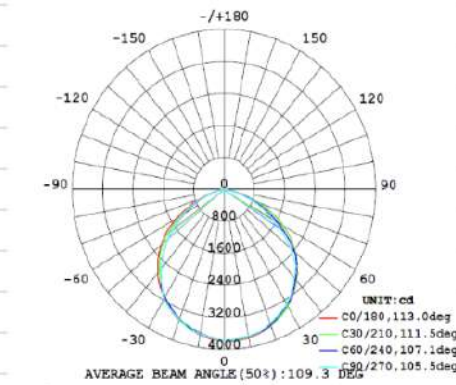

100 W

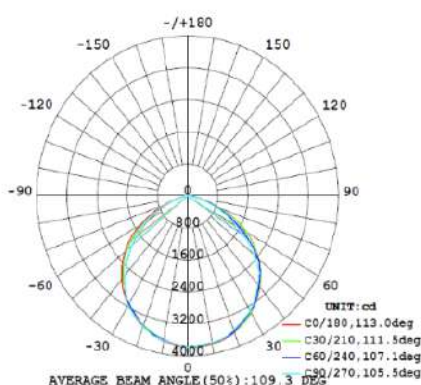

150 W

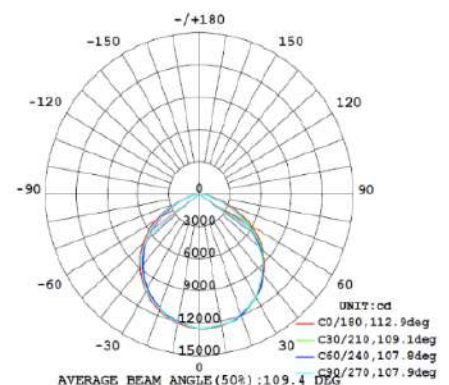

200 W

DISCLAIMER

The information in the present datasheet is subject to change without notice. Errors and omissions excepted. Please make sure to use the latest version.

FOR MORE INFORMATION

VESRA MEA LLC - FZ 1907, Opal Tower,
 Business Bay, Dubai, UAE
 Website: honeywell-lighting.com
 Email: support@honeywell-lighting.com
 Phone: +971 800 83 772

The Honeywell trademark is used under license from Honeywell International Inc. This product is manufactured by VESRA MEA LLC - FZ.

